

ELYA M-45 LEM-3045LWN SmartZ®

Taric 9405114090



Normes techniques

EN-60598-1, EN-60598-2-22, EN-62034, NF-C71-800, NF-C71-820, NF-413

Certifications



Spécifications fonctionnelles



Bloc Autonome d'Éclairage de Sécurité EVACUATION



Système de contrôle: Wireless SmartZ®



AutoTest: Oui



Type: Non permanent



Alimentation: 230V~50Hz 0,25Wmax



Consommation en mode non permanent: 0,25 W



Flux assigné: 45 lm



Autonomie: 1 h
Batterie: 3.2V-0.5Ah LiFePO₄



Temps de charge: 12 h



Télécommande: Oui

Spécifications Mécaniques et Esthétiques



Possibilité d'installation: Saillie mural



Isolation: Classe II



IP44



IK04



Source lumineuse: 16 x LED 0.5W



Température de couleur des LED: 6000 K



Composition base, réflecteur, patère: Polycarbonate



Coleur: Noir RAL9005



Diffuseur / Optique: Méthacrylate



Température de fonctionnement: 0 / 40 °C



Apte pour montage en surfaces inflammables: Oui



ELYA M-45 LEM-3045LWN

Caractéristiques d'installation

Installation avec patère de fixation.

Possibilité d'installation:

- Saille Mural

Possibilité de connexion:

- Câblage encastré
- Câblage du tube de surface



Caractéristiques de fonctionnement

Ce luminaire est compatible avec le système intelligent de gestion de l'éclairage de secours SmartZ®, conçu pour faciliter la maintenance et le contrôle de l'installation.

Grâce à sa capacité de communication sans fil 2,4 GHz, il crée un réseau maillé dynamique qui permet la connexion de plus de 10 000 luminaires sans nécessiter de câblage supplémentaire.

Le système permet une surveillance en temps réel, générant des alertes automatiques en cas de défaut potentiel et éliminant la nécessité d'inspections manuelles individuelles.

De plus, il permet l'intégration avec d'autres systèmes, qu'ils soient câblés ou sans fil.

En cas de non-connexion à la Malla, le luminaire fonctionnera en mode Autotest, exécutant automatiquement les tests détaillés ci-dessous.

BAES contrôlé par microprocesseur qui effectue des tests périodiques et automatiques.







Test fonctionnel tous les **7 jours**.



Test d'autonomie tous les **365 jours**.

Le résultat des tests est affiché par les LEDs d'état.

Le BAES dispose de LEDs d'état qui indiquent:

- | | | |
|---|--|---|
|  Vert allumé : fonctionnement correct |  Orange allumé : batterie ou autonomie incorrecte |  Les deux leds éteintes : absence d'alimentation ou panne totale du BAES |
|  Vert clignotant : test en cours |  Clignotement orange : défaut fonctionnel | |

Accessoires



CSZ003
SMARTZ CONTROL UNIT+ UAS
CSZ002+SAI002

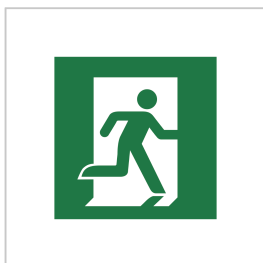

APE001
PICT ELYA
HOMME



APE002
PICT ELYA
FLÈCHE



APE004
PICT ELYA
SORTIE POUR PMR

ELYA M-45 LEM-3045LWN

Tableau d'espacements

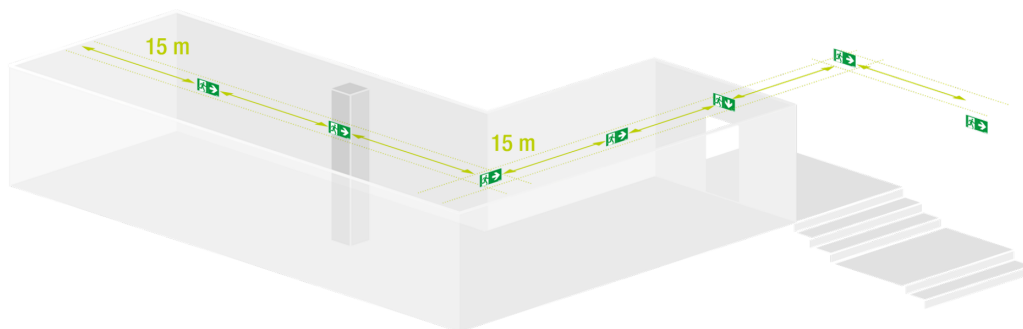

Un BAES Évacuation doit être placé à chaque obstacle, changement de direction, de niveau, ou sortie et issue de secours afin d'assurer l'éclairage des cheminements.
La distance maximale entre deux BAES Évacuation est de 15 mètres.

Poids (kg)



Poids du produit:
0.48 kg

Poids du produit emballé:
0.58 kg

Poids de la boîte de 18 unités:
7.29 kg

Dimensions (mm)

