

XENA FLAT

LXF-3045LD+

Taric 9405114090



8 436595713698



Normes techniques

EN-60598-1, EN-60598-2-22, EN-62034, NF-C71-800, NF-C71-820, NF-413

Certifications



Spécifications fonctionnelles



Bloc Autonome d'Éclairage de Sécurité EVACUATION



Système de contrôle: Câble SmartZ®



AutoTest: Oui



Bus de données: Oui



Type: Non permanent



Alimentation: 230V~ 50Hz 1.0 Wmax



Consommation en mode non permanent: 1,0 W



Flux assigné: 45 lm



Autonomie: 1 h
Batterie: 3.2V-0.5Ah LiFePO₄



Temps de charge: 12 h



Télécommande: Oui

Spécifications Mécaniques et Esthétiques



Possibilité d'installation: Saillie Plafond/Mural - Encastré plafond



Isolation: Classe II



IP42



IK04



Source lumineuse: 4 x LED 0.5W



Température de couleur des LED: 4000 K



Composition base, réflecteur, patère: Polycarbonate



Couleur: Blanc RAL9003



Diffuseur / Optique: Polycarbonate Transparent



Température de fonctionnement: 0 / 40 °C



Apte pour montage en surfaces inflammables: Oui



XENA FLAT LXF-3045LD+

Caractéristiques d'installation

Installation avec patère de fixation.

Possibilité d'installation:

- Saille Plafond / Mural
- Encastré plafond
- Mur semi-encastré

Possibilité de connexion:

- Câblage encastré
- Câblage avec tube de surface (max M20)



Caractéristiques de fonctionnement

Ce luminaire est compatible avec le système intelligent de gestion de l'éclairage de secours SmartZ®, conçu pour faciliter la maintenance et le contrôle de l'installation.

Le système permet une surveillance en temps réel, générant des alertes automatiques en cas de défaut potentiel et éliminant la nécessité d'inspections manuelles individuelles. De plus, il permet l'intégration avec d'autres systèmes, qu'ils soient câblés ou sans fil. La communication se fait par deux fils avec polarité, connectés à une Centrale de Contrôle CWS, permettant son intégration dans l'écosystème SMARTZ.

En cas de non-connexion à la Centrale CWS, le luminaire fonctionnera en mode Autotest, exécutant automatiquement les tests détaillés ci-dessous.

BAES contrôlé par microprocesseur qui effectue des tests périodiques et automatiques.







Test fonctionnel
tous les **7 jours**.



Test d'autonomie
tous les **365 jours**.

Le résultat des tests est
affiché par les LEDs d'état.

Le BAES dispose de LEDs d'état qui indiquent:

- | | | |
|---|--|---|
|  Vert allumé : fonctionnement correct |  Orange allumé : batterie ou autonomie incorrecte |  Les deux leds éteintes : absence d'alimentation ou panne totale du BAES |
|  Vert clignotant : test en cours |  Clignotement orange : défaut fonctionnel | |

Accessoires



AMD0041
CADRE ENCASTREMENT XENA FLAT
PLAFOND BLANC



AKD010
ACCESSOIRE XENA FLAT
IK10

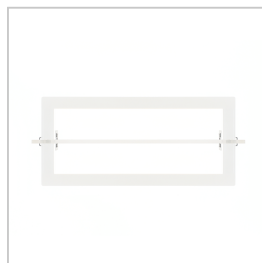

90091NMF
PORTE ETIQUETTE XENA FLAT
ENCASTRE PLAFOND BLANC



KAPE0065
KIT ETANCHEITE XENA FLAT
ENVELOPPE IP65 / IK10

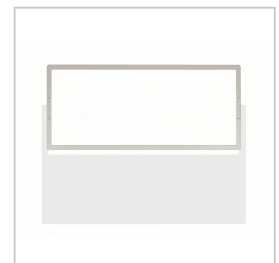

90095NMF
PORTE ETIQUETTE XENA FLAT
SAILLIE PLAFOND BLANC

XENA FLAT LXF-3045LD+

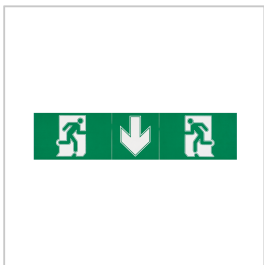

APV0000P

ETIQUETTE ADHESIVE XENA FLAT
 MULTI-DIRECTION OPAQUE

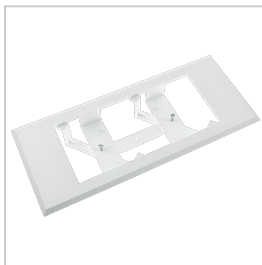

AMU8001

ACCESSOIRE XENA FLAT / DIANA
 CADRE UNIVERSEL

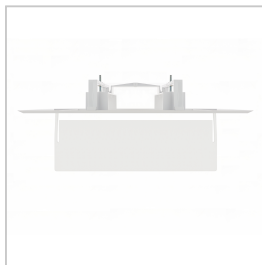

AMU8004

ACCESSOIRE XENA FLAT / DIANA
 CADRE UNIV. + PORTE ETIQUETTE

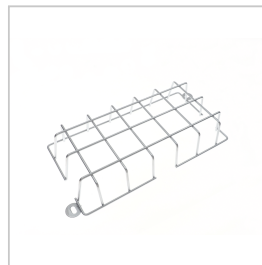

AGV-60-NM

GRILLE DE PROTECTION XENA FLAT
 IK10

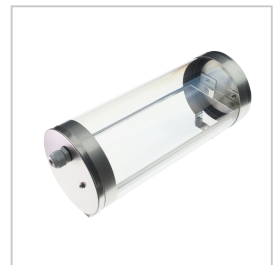

KEYC

KIT ENVELOPPE CYLINDRIQUE XENA
 SECURINOX

Tableau d'espacements

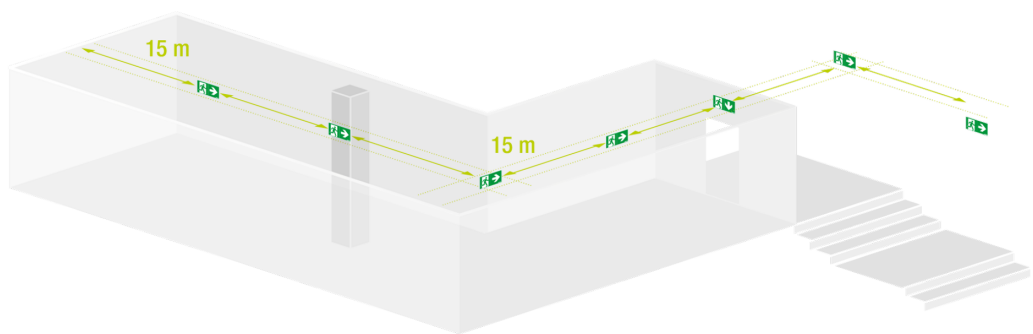

Un BAES Évacuation doit être placé à chaque obstacle, changement de direction, de niveau, ou sortie et issue de secours afin d'assurer l'éclairage des cheminements.
 La distance maximale entre deux BAES Évacuation est de 15 mètres.

Guide photométrique

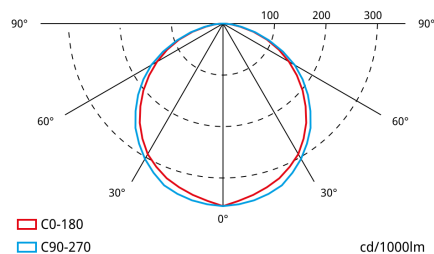

XENA FLAT LXF-3045LD+

Poids (kg)



Poids du produit:
0.52 kg

Poids du produit emballé:
0.57 kg

Poids de la boîte de 18 unités:
10.56 kg



Dimensions (mm)

